

BOX C125

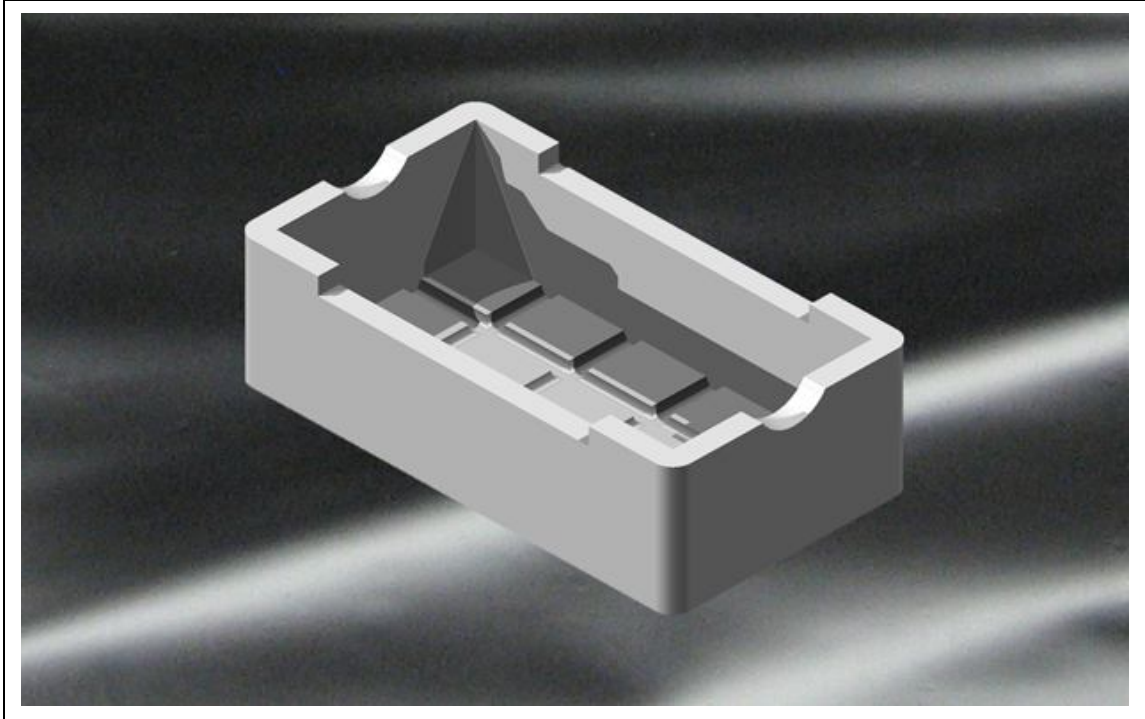

ITEM DESCRIPTION

Eps box for dairy products

MATERIAL

Sintered expanded polystyrene EPS white

EXTERNAL DIMENSIONS:

245 x 135 H78 mm

CAPACITY:

1,6 liters

RAW MATERIALS USED ARE SUITABLE TO COME IN CONTACT WITH FOOD

